

UDI001 USER MANUAL

Note

- ▲ This product is suitable for users over 14 years old.
- ▲ Stay away from the rotating propeller
- ▲ Read the “important statement and safety guidelines” carefully.
<https://udirc.com/disclaimer-and-safety-instructions>



Li-Po Battery Disposal & Recycling

Wasted Lithium-Polymer batteries must not be placed with household trash. Please contact local environmental or waste agency or the supplier of your model or your nearest Li-Po battery recycling center.



Important Notice

Our company's products are improving all the time, design and specifications are subject to change without notice. All the information in this manual has been carefully checked to ensure accuracy, if any printing errors, our company reserves the final interpretation right.

Ready before sailing

Preparation the boat

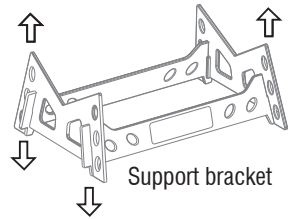
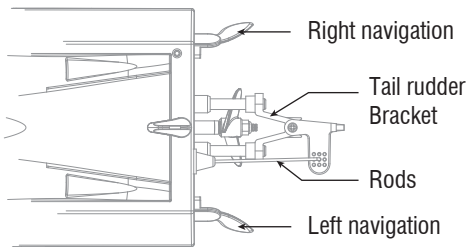
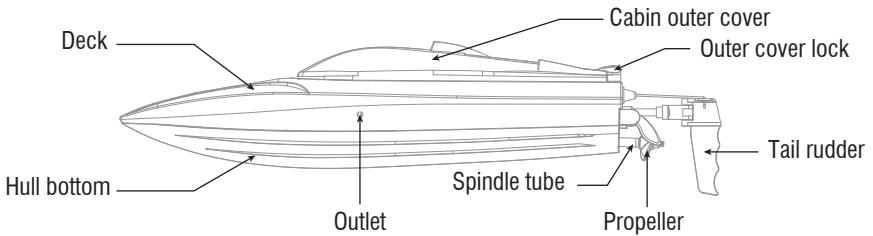

Battery Charge

Battery power is insufficient in the original plant. It must be charged saturated before it can be used.

Connect the charging case to the charging input port of the boat battery and then connect the USB output ports. The green indicator light flashes when charging and the green indicator light will keep bright fully charged. During the charging, battery should not be placed in the hull when charging and must be cooled before charging.

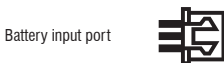

▲ Please use the charging case to charger and make sure it is properly connected.

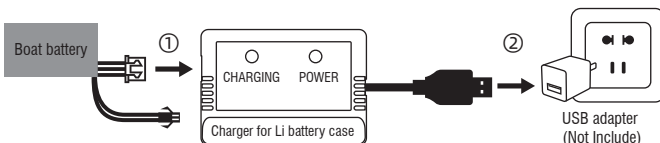

Boat battery installation method

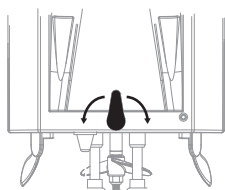

① Twist to left or right to open the outer cover lock.

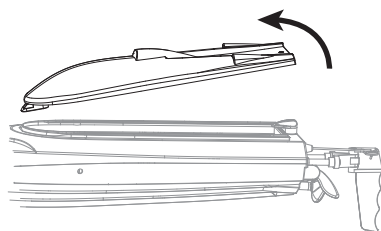

② open up the cabin cover.

③ Put the Li-po battery into the boat battery holder, the power line of the battery puts on the side of the hull, push the battery to the end and stick to it.

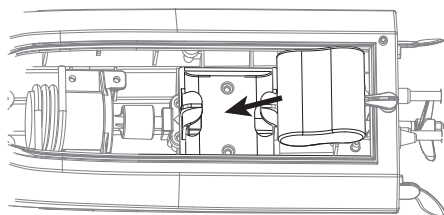

④ Properly connected the hull input port to the output port of the Boat battery.



Hull input port

Battery output port

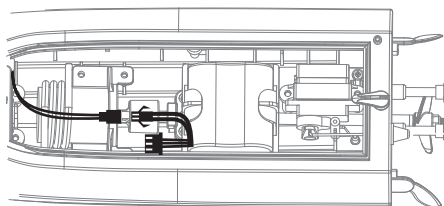

⑤ Cover the cabin and lock tightly.

Head Cover Installation

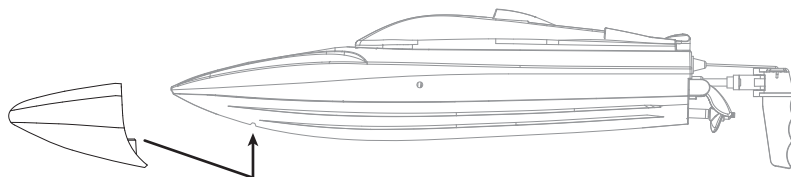

Align the head cover with the bottom hole of the boat and install it in the right place.

Transmitter Preparation

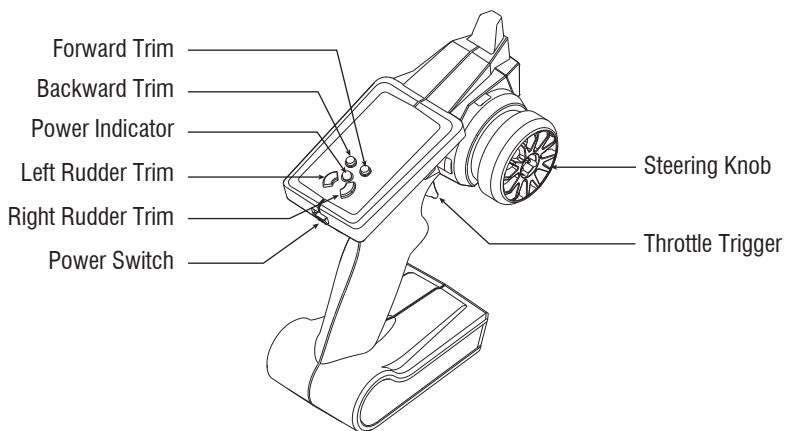

Battery installation of transmitter

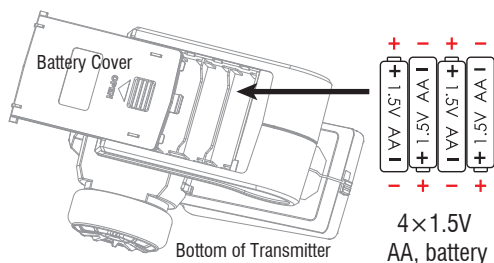

Open the battery cover of the transmitter and place the same type of battery with saturated capacity according to the '+ -' electrode indication in the battery cell. (battery not included)

Sailing Operation

Transmitter connect with Boat

Frequency Pairing

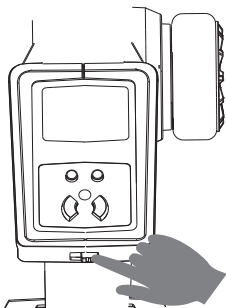

Please make sure the transmitter throttle stick and rudder knob to normal.

- ① Power on the transmitter, will sound "di", and the indicator light flashes, then to enter frequency pairing.
- ② After the boat battery is installed and powered on, tighten the hatch cover.
- ③ Put the boat into the water, the transmitter will sound "didi", and the indicator will keep long bright it means frequency pairing successful.

It is recommended to be familiar with the operation on the surface of the water before long distance navigation.

How to Operate the Boat

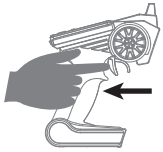

To move Forward

Pull back the throttle trigger of the transmitter. The boat moves forward.

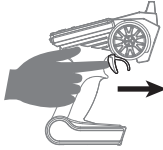

To move Backward

Push forward the throttle trigger of the transmitter. The boat moves backwards.

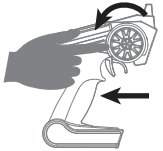

To turn Left

Pull back the throttle trigger of the transmitter and move the steering knob counterclockwise, then the boat turns left.



To turn Right

Pull back the throttle trigger of the transmitter and move the steering knob clockwise then the boat turns right.

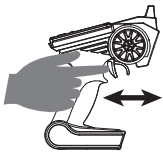

Self-Righting Hull

If the boat capsizes, Push forward and backward the throttle trigger of the transmitter and then pull back at once. The boat will then return to normal, the capsize reset function will turn off automatically when the boat in low battery.



Trimmer

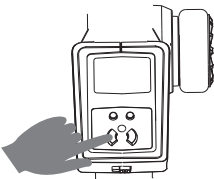

Left Rudder Trim

If the boat drifts to the right, press the left rudder trim on the transmitter and the boat will gradually correct the rudder alignment. It will start moving straight.

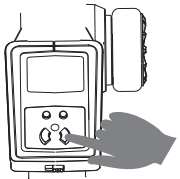
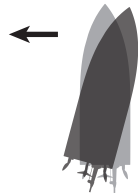

Right Rudder Trim

If the boat drifts to the left, press the right rudder trim on the transmitter and the boat will gradually correct the rudder alignment. It will start moving straight.

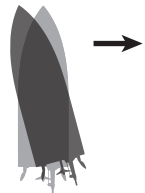

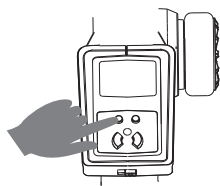

Backward Trim

If the boat still moves forward when the throttle trigger is in the middle position, press backward trim until the boat stops going forward.

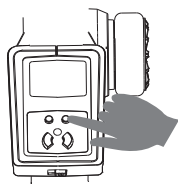

Forward trim

If the boat still moves backwards when the throttle trigger is in the middle position, press forward trim until the boat stops going backwards.



Low Battery Alarm

Boat: When the boat in low battery, the transmitter will beep “di.di.di. ...” constantly to remind the user to remote back the boat as soon as possible. And the boat speed will slow down to half and the capsized reset function will turn off automatically when the boat in low battery.

Transmitter: When the transmitter in low battery, the transmitter will beep “di.di.di. ...” to remind the user to remote back the boat to replace the batteries as soon as possible.

Out of Range Alarm

When the boat is running out of the max remote control distance, the transmitter will beep “didi...didi...” to alarm the user to remote back the boat immediately.

Out of water protection

Only when the boat is in the water can it work normally. Stop working after leaving the water surface, prevent misoperation and play a role of safety protection.

Water cooling system

The motor lowers the temperature by flowing water. During the voyage, water flows through the heat pipe around the motor, which has a cooling effect on the motor.

Parts Replacement

Propeller Replacement

Remove:

Unscrew the nut and take out the propeller.

Installation:

Insert the propeller and tighten nut.

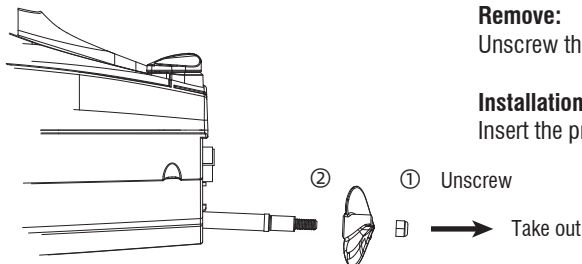

Safety Precautions

- ① Turn on the transmitter power first and then turn on the boat power before playing; Turn off the boat power first and then turn off the transmitter power when finish playing.
- ② Make sure the connection is solid between battery and motor etc. The ongoing vibration may cause bad connection of power terminal.
- ③ Improper operation may cause impact to the boat and damage the hull or propeller.
- ④ It is forbidden to sail in the water where people are useful and sail away from salt water and sundry water.
- ⑤ The battery must be take out after playing to keep the cabin dry and clean.

Troubleshooting Guide

No.	Problem	Problem Cause	Solution
1	The transmitter indicator light is off.	1. Low battery.	1. Replace the transmitter battery.
		2. The battery positive pole and negative pole are in reverse order.	2. Install the battery in accordance with the user manual.
		3. Poor Contact.	3. Clean the dirt between the battery and the battery slice.
2	Fail to pair the boat with transmitter.	1. Indicator light is off.	1. The same as above 1.2.3.
		2. There is interfering signal nearby.	2. Restart the boat and power on the transmitter.
		3. Improper operation.	3. Operate the boat step by step in accordance with the user manual.
		4. The electronic component is damaged for frequent crash.	4. To buy spare parts from local seller and replace damaged parts.
3	The boat is under-powered or can not sail.	1. The propeller deformed seriously.	1. Replace the propeller.
		2. Incorrect installation of propeller.	2. Install the propeller in accordance with the user manual.
		3. Low battery.	3. Recharge the drone battery as per instruction.
		4. The battery is expired or over discharge protection.	4. Buy a new battery from local seller to replace the battery.
		5. Poor contact.	5. Disconnect the battery and then connect it with the plug again.
4	The boat tilts to one side.	1. The steering gear arm is not vertical seriously.	1. Calibrate the steering gear arm as per instruction.
		2. The tail rudder is not vertical seriously.	2. Calibrate the tail rudder as per instruction.
		3. The steering gear slips.	3. Replace the new steering gear as per instruction.

FCC Note

This equipment has been tested and found to comply with the limits for a Class B digital device, pursuant to Part 15 of the FCC Rules. These limits are designed to provide reasonable protection against harmful interference in a residential installation. This equipment generates uses and can radiate radio frequency energy and, if not installed and used in accordance with the instructions, may cause harmful interference to radio communications. However, there is no guarantee that interference will not occur in a particular installation. If this equipment does cause harmful interference to radio or television reception, which can be determined by turning the equipment off and on, the user is encouraged to try to correct the interference by one or more of the following measures:

- Reorient or relocate the receiving antenna.
- Increase the separation between the equipment and receiver.
- Connect the equipment into an outlet on a circuit different from that to which the receiver is connected.

WARNING: Changes or modifications not expressly approved by the party responsible for compliance could void the user's authority to operate the equipment.

The equipment may generate or use radio frequency energy. Changes or modifications to this equipment may cause harmful interference unless the modifications are expressly approved in the instruction manual. Modifications not authorized by the manufacturer may void user's authority to operate this device.

This device complies with Part 15 of the FCC Rules. Operation is subject to the following two conditions:

- (1) This device may not cause harmful interference.
- (2) This device must accept any interference received, including interference that may cause undesired operation.

FCC Radiation Exposure Statement

The device has been evaluated to meet general RF exposure requirement.
The device can be used in portable exposure condition with out restriction.

⚠ WARNING

Warning: The product should only be used by adults and children over 14 years.

Adult supervision is required for children under 14 years.

Hinweis: Dieses Produkt ist für die Erwachsene und die Kinder ab 14 Jahren.

Die kinder unter 14 Jahren müssen von Erwachsenen beaufsichtigt werden.

Avertissement: Ce produit est destiné aux adultes et aux enfants de plus de 14 ans.

Les enfants de moins de 14 ans doivent être surveillés par des adultes.

Avvertimento: Questo prodotto è destinato all'uso per i adulti e bambini di età superiore ai 14 anni.

I bambini di età inferiore ai 14 anni devono essere sorvegliati da un adulto.

Advertencia: Este producto es para adultos y niños mayores de 14 años.

Los niños menores de 14 años deben ser supervisados por adultos.

警告: この製品は、大人と14歳以上の子供には使用対象です。14歳未満の子供は大人の監視が必要です。



DANGER!

Only suitable for age 14+



Manufacturer: SHANTOU CITY CHENGHAI UDIRC TOYS CO., LTD

Address: Guangfeng Industrial Zone, Guangyi Street, Chenghai District, Shantou City, Guangdong Province, CN

Model: UDI001

Manufacture time:

MADE IN CHINA